



STRIVE[®] READYSPACE[®]

Dual Technology Carpet Cleaner



5



Setup

See Backside

After Use

6



Before Use

1



1017131 Case 4 - 1 gal

7



2

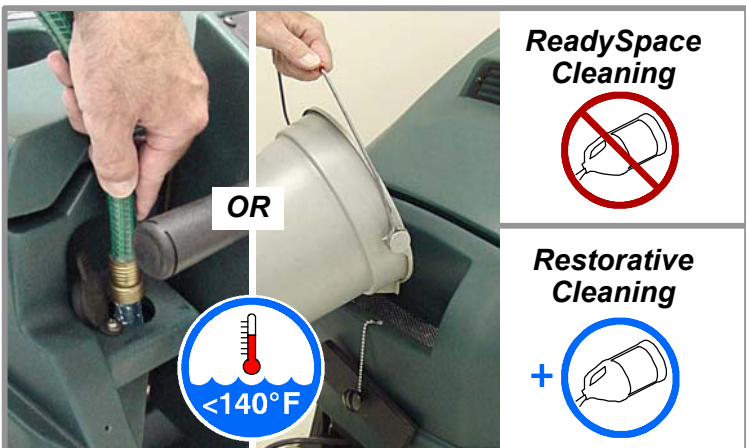

8

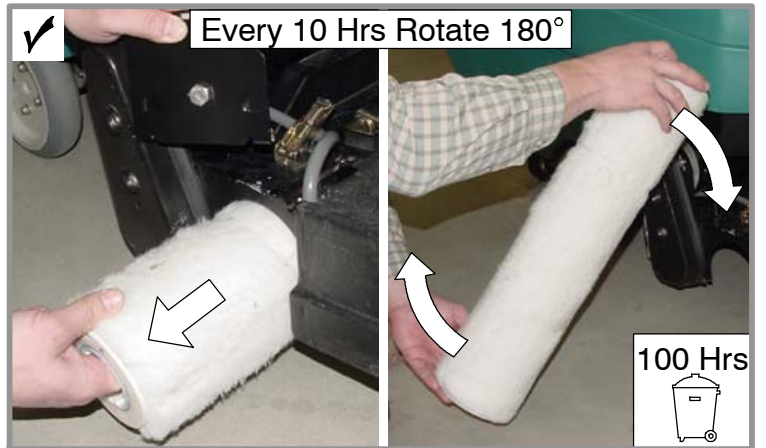

Operate

3

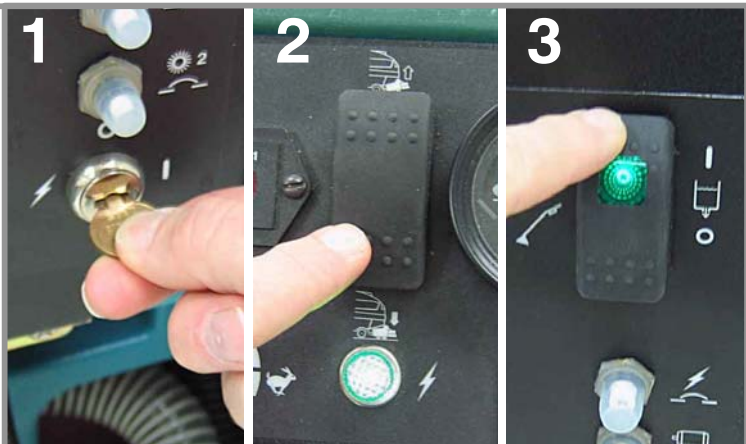

9

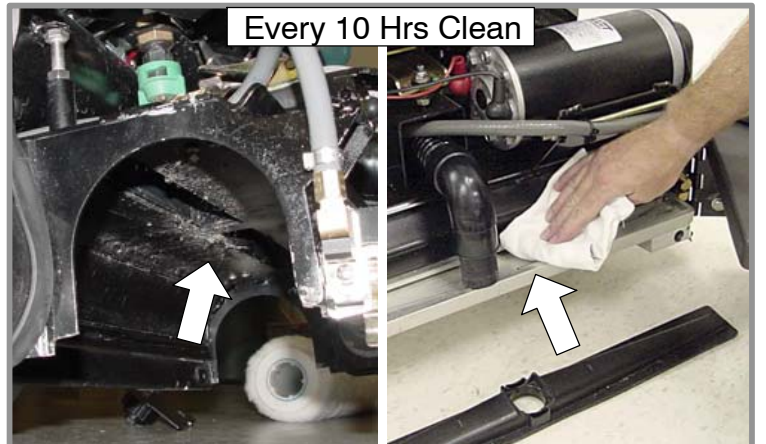

4

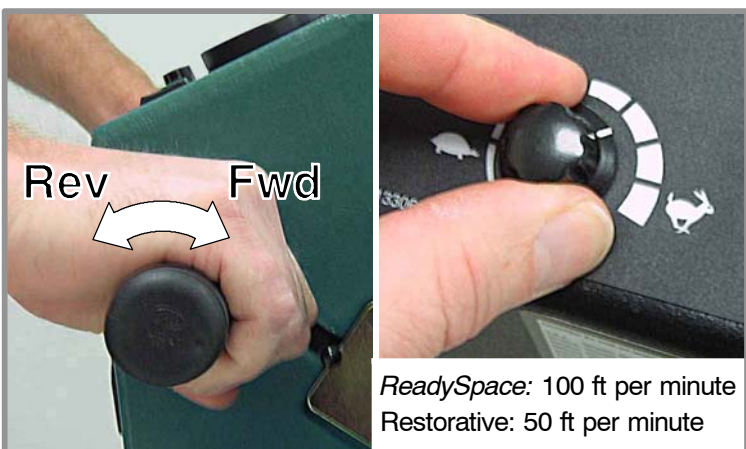

10



Setup ReadySpace Cleaning

FOR SAFETY: Remove key from machine before performing setup procedure.

1. Install the two ReadySpace Rollers.
2. Install rear ReadySpace Vacuum Shoe.
3. Connect the two Solution Flush Lines to Vacuum Shoe.
4. Connect Vacuum Tube to Vacuum Shoe.
5. Connect Vacuum Hose to Vacuum Tube.

Equipment Needed:

- 1) Two ReadySpace Rollers
- 2) Rear ReadySpace Vacuum Shoe
- 3) 6 mm Hex Head Tool (supplied with machine)

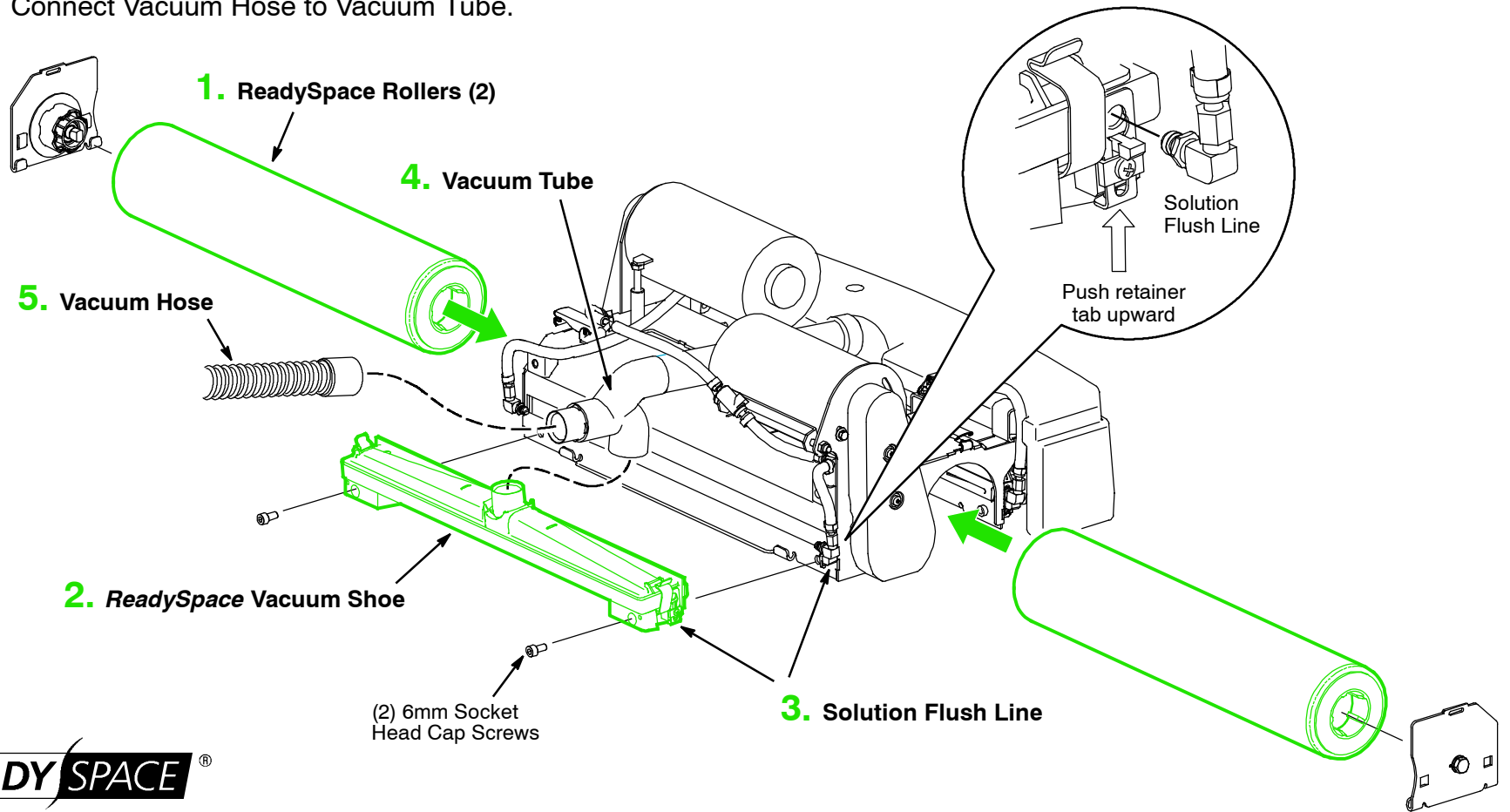
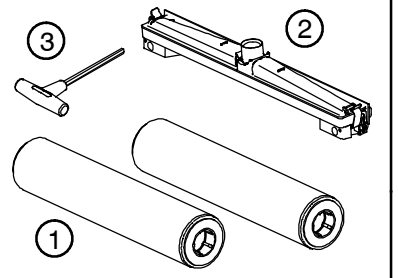

READYSPACE®

Setup Restorative Cleaning

FOR SAFETY: Remove key from machine before performing setup procedure.

1. Install the two Restorative Brushes.
2. Install Restorative Vacuum Shoe.
3. Connect Vacuum Hose to Vacuum Shoe.

NOTE: To prevent misplacing the ReadySpace Vacuum Tube and Solution Flush Lines Do Not remove from Scrub Head.

Equipment Needed:

- 1) Two Restorative Brushes
- 2) Restorative Vacuum Shoe
- 3) 6 mm Hex Head Tool (supplied with machine)

